



## INSTRUCTION MANUAL

VHF TRANSCEIVER

**IC-F3161T/S/DT/DS**  
**IC-F3163T/S**

UHF TRANSCEIVER

**IC-F4161T/S/DT/DS**  
**IC-F4163T/S**

This device complies with Part 15 of the FCC Rules. Operation is subject to the condition that this device does not cause harmful interference.

**Icom Inc.**



---

## IMPORTANT

---

**READ ALL INSTRUCTIONS** carefully and completely before using the transceiver.

**SAVE THIS INSTRUCTION MANUAL** — This instruction manual contains important operating instructions for the **IC-F3161T/S/DT/DS, IC-F3163T/S VHF TRANSCEIVERS** and **IC-F4161T/S/DT/DS, IC-F4163T/S UHF TRANSCEIVERS**.

 See the operating guide for details of Digital, BIIS, MDC and LTR® system operations. Ask your dealer for details.

---

## EXPLICIT DEFINITIONS

---

WORD	DEFINITION
 <b>WARNING</b>	Personal injury, fire hazard or electric shock may occur.
<b>CAUTION</b>	Equipment damage may occur.
<b>NOTE</b>	If disregarded, inconvenience only. No risk of personal injury, fire or electric shock.

---

## TABLE OF CONTENTS

---

IMPORTANT.....	i
EXPLICIT DEFINITIONS.....	i
TABLE OF CONTENTS.....	i
PRECAUTIONS.....	ii
<b>1 ACCESSORIES.....</b>	<b>1-3</b>
■ Supplied accessories.....	1
■ Accessory attachments.....	1
<b>2 PANEL DESCRIPTION.....</b>	<b>4-10</b>
■ Front panel.....	4
■ Function display.....	5
■ Programmable function keys.....	6
<b>3 BASIC OPERATION.....</b>	<b>11-17</b>
■ Turning power ON.....	11
■ Channel selection.....	12
■ Call procedure.....	13
■ Receiving and transmitting.....	13
■ User set mode.....	16
■ Emergency transmission.....	16
■ Man Down Emergency Call.....	16
■ Scrambler function.....	17
■ Stun function.....	17
■ Priority A channel selection.....	17
<b>4 BATTERY CHARGING.....</b>	<b>18-22</b>
■ Caution.....	18
■ Optional battery chargers.....	20
<b>5 BATTERY CASE.....</b>	<b>23</b>
■ Optional battery case (BP-240).....	23
<b>6 SWIVEL BELT CLIP.....</b>	<b>24-25</b>
■ MB-93 contents.....	24
■ To attach.....	24
■ To detach.....	25
<b>7 SPEAKER MICROPHONE.....</b>	<b>26</b>
■ Optional HM-169/170GP description.....	26
■ To attach.....	26
<b>8 OPTIONS.....</b>	<b>27-30</b>
<b>9 SAFETY TRAINING INFORMATION.....</b>	<b>31-32</b>

---

## PRECAUTIONS

---

⚠ **CAUTION! NEVER** hold the transceiver so that the antenna is very close to, or touching exposed parts of the body, especially the face or eyes, while transmitting. The transceiver will perform best if the microphone is 2 to 4 in. (5 to 10 cm) away from the lips and the transceiver is vertical.

⚠ **CAUTION! NEVER** operate the transceiver with a headset or other audio accessories at high volume levels.

⚠ **CAUTION! NEVER** short the terminals of the battery pack.

**DO NOT** push [PTT] when not actually desiring to transmit.

**DO NOT** use or place the transceiver in direct sunlight or in areas with temperatures below +22°F (−30°C) or above +140°F (+60°C).

The basic operations, transmission and reception of the transceiver are guaranteed within the specified operating temperature range. However, the LCD display may not operate correctly, or show an indication in the case of long hours of operation, or after being placed in extremely cold areas.

**DO NOT** modify the transceiver. The transceiver warranty does not cover any problems caused by unauthorized modification.

**KEEP** the transceiver away from the heavy rain, and **Never** immerse it in the water. The transceiver is **water resistant**, not waterproof.

Use of non-Icom batteries could result in the degradation of the transceivers performance or voiding the warranty.

Icom optional equipment is designed for optimal performance when used with this transceiver. We are not responsible for the transceiver being damaged or any accident caused when using non-Icom optional equipment.

### *For U.S.A. only*

**CAUTION!** Changes or modifications to this transceiver, not expressly approved by Icom Inc., could void your authority to operate this transceiver under FCC regulations.

Icom, Icom Inc. and the ICOM logo are registered trademarks of Icom Incorporated (Japan) in the United States, the United Kingdom, Germany, France, Spain, Russia and/or other countries.

LTR is a registered trademark of the E.F.Johnson Company. All other products or brands are registered trademarks or trademarks of their respective holders.

1

2

3

4

5

6

7

8

9

## ■ Supplied accessories

The following accessories are supplied.

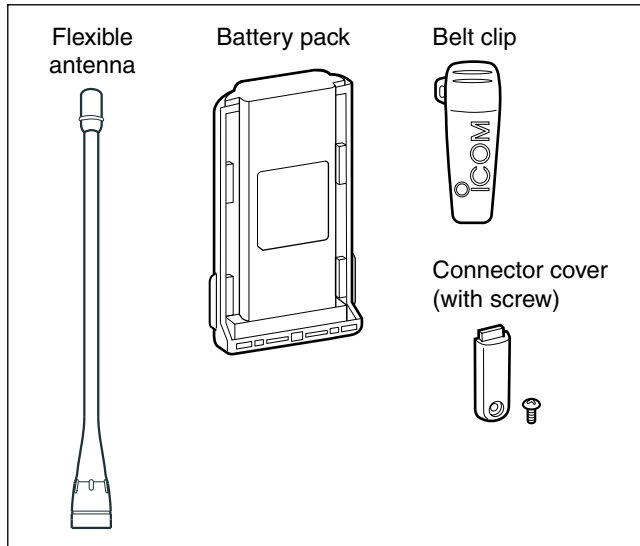

## ■ Accessory attachments

### ◇ Flexible antenna

Connect the supplied flexible antenna to the antenna connector.

### CAUTION!

- **NEVER HOLD** the antenna when carrying the transceiver.
- Transmitting without an antenna may damage the transceiver.

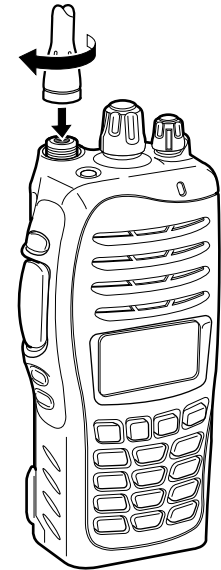

## ◇ Battery pack

### *To attach the battery pack:*

Slide the battery pack on the back of the transceiver in the direction of the arrow (1), then lock it with the battery release button.

- Slide the battery pack until the battery release button makes a 'click' sound.

### *To release the battery pack:*

Push the battery release button in the direction of the arrow (2) as shown below. The battery pack is then released.

**NEVER** release or attach the battery pack when the transceiver is wet or soiled. This may result water or dust getting into the transceiver/battery pack and may result in the transceiver being damaged.

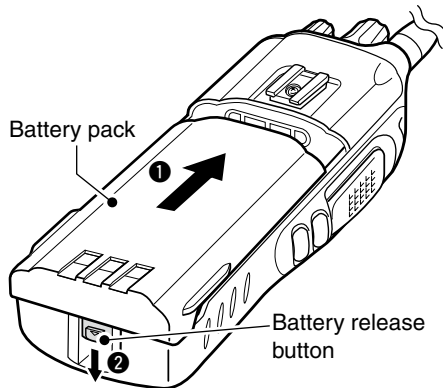

**NOTE:** Keep the battery pack terminals clean. It's a good idea to clean the battery pack terminals once a week.

## ◇ Belt clip

### *To attach the belt clip:*

- ① Release the battery pack if it is attached.
- ② Slide the belt clip in the direction of the arrow until the belt clip is locked and makes a 'click' sound.

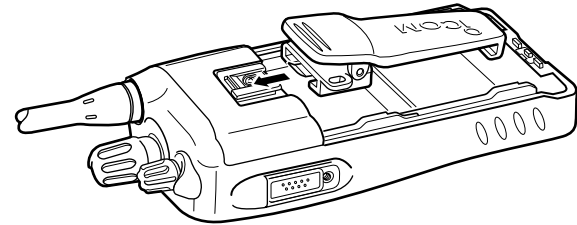

### *To detach the belt clip:*

- ① Release the battery pack if it is attached.
- ② Pinch the clip (1), and slide the belt clip in the direction of the arrow (2).

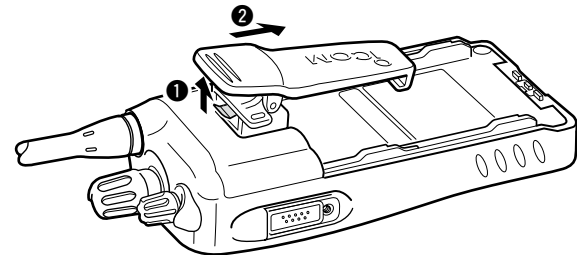

# 1 ACCESSORIES

## ◇ Connector cover

Attach the connector cover when the optional equipment is not used.

### *To attach the connector cover:*

- 1 Insert the connector cover into the multi-connector.
- 2 Tighten the screw.

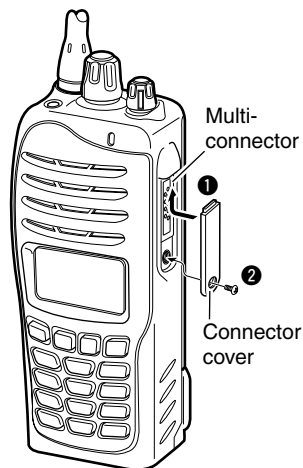

### *To detach the connector cover:*

- 1 Unscrew the screw using a phillips screwdriver.
- 2 Detach the connector cover for the optional equipment connector.

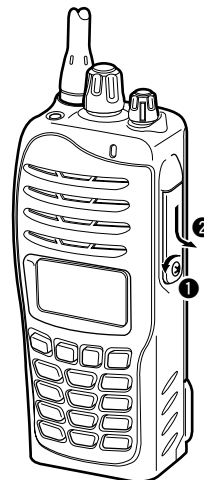

## **CAUTION!**

Attach the connector cover when the optional equipment is not used. Otherwise the terminals of the multi-connector may be shorted by metal object, etc., and this could damage the transceiver.

## ■ Front panel

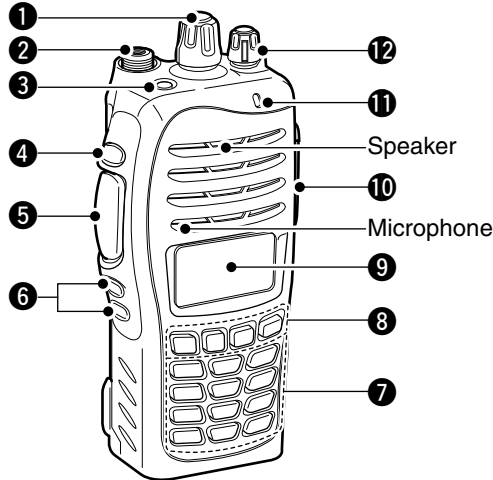

### ① ROTARY SELECTOR

Rotate to select the pre-programmed memory channels or the operating zone. (Depending on the pre-setting)

### ② ANTENNA CONNECTOR

Connects the supplied antenna. (p. 1)

### ③ DEALER-PROGRAMMABLE KEY [EMR]

Desired function can be programmed by your dealer. (p. 6)

### ④ DEALER-PROGRAMMABLE KEY [Side1]

Desired function can be programmed by your dealer. (p. 6)

### ⑤ PTT SWITCH [PTT]

Push and hold to transmit; release to receive.

### ⑥ DEALER-PROGRAMMABLE KEYS [Side2]/[Side3]

Desired function can be programmed independently by your dealer. (p. 6)

### ⑦ 10-KEYPAD (Depending on version)

The keypad allows you to enter digits to:

- Select memory channels
- Select tone channels
- Select DTMF codes (during transmit)
- Set TX codes
- Start up with the password

### ⑧ DEALER-PROGRAMMABLE KEYS [P0] to [P3]

Desired function can be programmed independently by your dealer. (p. 6)

### ⑨ FUNCTION DISPLAY (p. 5)

Displays a variety of information such as an operating channel number/name, Set mode contents, DTMF code, selected function, etc.

## 2 PANEL DESCRIPTION

### 10 MULTI-CONNECTOR

Connect an optional equipment.

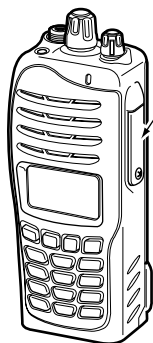

Connector cover

**NOTE:** Attach the connector cover when the optional equipment is not used. See p. 3 for details.

### 11 BUSY/TRANSMIT INDICATOR

- Lights green while receiving a signal, or when the squelch is open.
- Lights red while transmitting.

### 12 VOLUME CONTROL [VOL]

Rotate to turn the power ON/OFF and adjusts the audio level.

## Function display

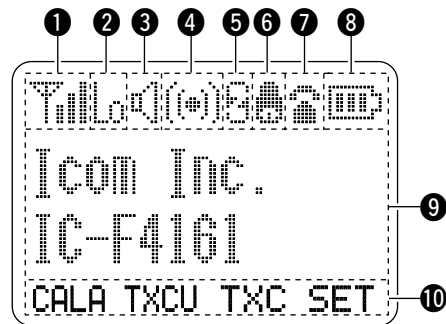

### 1 SIGNAL STRENGTH INDICATOR

Indicates relative signal strength level.

### 2 LOW POWER INDICATOR

Appears when low output power is selected.

### 3 AUDIBLE INDICATOR

- Appears when the channel is in the 'audible' (unmute) condition.
- Appears when the matched signal is received.

### 4 COMPANDER INDICATOR

Appears when the compander function is activated.

### 5 SCRAMBLER INDICATOR

Appears when the voice scrambler function is activated.

**6 BELL INDICATOR**

Appears/blinks when the matched signal is received, according to the pre-programming.

**7 CALL CODE MEMORY INDICATOR**

Appears when the call code memory is selected.

**8 BATTERY INDICATOR**

Appears or blinks when the battery power decreases to a specified level.

Indication				
Battery level	Full	Middle	Charging required	No battery

blinks when the battery is over charged.

blinks when the battery is exhausted.

**9 ALPHANUMERIC DISPLAY**

- Displays an operating channel number, channel name, Set mode contents, DTMF code, etc.
- The indication mode can be selected from 1 line or 2 lines. Ask your dealer for details.
  - In this instruction manual, the LCD illustration is described using the 2 lines indication mode.

**10 KEY INDICATOR**

Indicate the programmed function of the front panel keys ([P0], [P1], [P2] and [P3]).

**■ Programmable function keys**

The following functions can be assigned to [EMR], [Side1], [Side2], [Side3], [P0], [P1], [P2] and [P3] programmable function keys.

Consult your Icom dealer or system operator for details concerning your transceivers programming.

If the programmable function names are bracketed in the following explanations, the specific key is used to activate the function depends on the programming.

**CH UP AND DOWN KEYS “UP” “DOWN”**

- Push to select an operating channel. When [Rotary selector] selects “operating channel,” this key is not available.
- Push to select a transmit code channel after pushing [TX Code CH Select].
- Push to select a DTMF channel after pushing [DTMF Autodial].
- Push to select a scan group after pushing and holding [Scan A Start/Stop]/[Scan B Start/Stop].
- Push to select a talkgroup ID, TX status message and SDM (Short Data Message) after pushing [Digital Button].

---

## 2 PANEL DESCRIPTION

### **ZONE KEY “ZONE”**

Push this key, then push [CH Up] or [CH Down] to select the desired zone. When [Rotary selector] selects “operating zone,” this key operation is not available.

 **What is “zone”?**— Selected channels are assigned to a zone according to how they are to be used in a group. For example, ‘Staff A’ and ‘Staff B’ are assigned into a “Business” zone, and ‘John’ and ‘Cindy’ are assigned into a “Private” zone.

### **ZONE UP AND DOWN KEYS “ZNUF” “ZNDN”**

Push to select an operating zone. When [Rotary selector] selects “operating zone,” this key is not available.

### **SCAN A KEY “SCNA”**

- ➔ Push to start and cancel scanning operation.
  - When Power ON Scan function is activated, push to pause the scanning operation. And the paused scan resumes after the specified time period has passed.
- ➔ Push and hold this key for 1 sec. to indicate the scan list, then push [CH Up] or [CH Down] to select the desired list.

### **SCAN B KEY “SCNB”**

- ➔ Push to start and cancel scanning operation.

The scan restarts after the specified time period has passed when the scan (started with this key) is canceled by except for this key operation.
- ➔ Push and hold this key for 1 sec. to indicate the scan list, then push [CH Up] or [CH Down] to select the desired list.

### **SCAN ADD/DEL (TAG) KEY “SCAD”**

- ➔ Push to add or delete the selected channel to/from the scan group.
  1. Push to indicate the scan group, then push [CH Up] or [CH Down] to select the desired group.
  2. Push to add or delete the channel to/from the selected scan group.
  3. Push and hold for 1 sec. to exit the scan group selection mode.
- ➔ Push this key while scan is paused (a signal is detected) on a channel (except for priority channel,) the channel is cleared from the scan group.

 Depending on the setting, the cleared channel is added to the scan group again after the scan is cancelled. (Nuisance Delete function)

### **PRIORITY CHANNEL KEYS “PRA” “PRAR” “PRB” “PRBR”**

- ➔ Push to select Priority A or Priority B channel.
- ➔ Push and hold [Prio A (Rewrite)] or [Prio B (Rewrite)] for 1 sec. to rewrite the Priority A or Priority B channel for the operating channel.

**MEMORY CH 1/2/3/4 KEYS** "CH1" "CH2" "CH3" "CH4"

Push to select the memory channels 1 to 4 directly.

**MONI KEY** "MON"

- Push to mute and release the CTCSS (DTCS) or 2-tone squelch mute. Open any squelch/deactivate any mute while pushing and holding this key. (LMR operation only)
- Activates one of (or two of) the following functions on each channel independently: (PMR operation only)
  - Push and hold to un-mute the channel (audio is emitted; 'Audible' condition).
  - Push to mute the channel (sets to 'Inaudible' only).
  - Push after the communication is finished to send a 'reset code'. (5-tone/BISS operation only)

 **NOTE:** The un-mute condition ('Audible' condition) may automatically return to the mute condition ('Inaudible' condition) after a specified period.

**LIGHT KEY** "LIGT"

Push to turn the transceiver's backlight ON temporarily only when the backlight function is turned OFF in user set mode.

**LOCK KEY** "LOCK"

- Push and hold for 1 sec. to electronically lock all programmable keys except the following: [PTT], [Call] (incl. Call A and Call B), [Moni(Audi)], [Light], [Emergency], [Surveillance] and [Lone Worker].
- Push and hold for 1 sec. again to turn the lock function OFF.

**LONE WORKER KEY** "LONE"

Push to turn the Lone Worker function ON or OFF.

- If the Lone Worker function is activated, the Emergency function is automatically turned ON after the specified time period has passed with no operation is performed.

**HIGH/LOW KEY** "H/L"

Push to select the transmit output power temporarily or permanently, depending on the pre-setting.

- Ask your dealer for the output power level for each selection.

**TONE/RAN CH SELECT KEY** "T SEL"

- While in analog mode operation, push to enter the continuous tone channel selection mode. Then select the desired tone frequency/code setting with [CH Up] or [CH Down]. After the selection, push this key again to set.
- While in digital mode operation, push to enter the RAN channel selection mode. Then select the desired RAN setting with [CH Up] or [CH Down]. After the selection, push this key again to set.
- While in mixed (digital and analog) mode operation, push to enter the continuous tone channel selection mode. Then select the desired tone frequency/code setting with [CH Up] or [CH Down]. After the selection, push this key to set. After that, the RAN channel selection screen appears. Select the desired RAN setting with [CH Up] or [CH Down]. After the selection, push this key again to set.

---

## 2 PANEL DESCRIPTION

### **C.TONE CH ENT KEY “TSEL”**

Push to enter the continuous tone channel selection mode. Then select the desired tone frequency/code setting with [CH Up]/[CH Down]. The selected channel remains set as the continuous tone channel until another channel is designated as such.

### **TALK AROUND KEY “TA”**

Push to turn the talk around function ON and OFF.

- The talk around function equalizes the transmit frequency to the receive frequency for transceiver-to-transceiver communication.

### **WIDE/NARROW KEY “W/N”**

Push to toggle the IF bandwidth between wide and narrow.

### **DTMF AUTODIAL KEY “DTMA”**

Push to enter the DTMF channel selection mode. Then select the desired DTMF channel using [CH Up]/[CH Down]. After selecting the DTMF channel, push again to transmit the selected DTMF code.

### **RE-DIAL KEY “DTMR”**

Push to transmit the last-transmitted DTMF code.

### **CALL KEYS “CALL” “CALA” “CALB”**

Push to transmit a 2/5-tone or BIIS ID code.

- Call transmission is necessary before you call another station depending on your signaling system.
- [Call A] and/or [Call B] may be available when your system employs selective ‘Individual/Group’ calls. Ask your dealer which call is assigned to each key.

### **EMERGENCY KEY “EMR”**

Push and hold to transmit the emergency call.

- The emergency call transmits with beeps; the display does not change.
- The transceiver can transmit the emergency call silently or with the display changes depending on the pre-setting. Ask your dealer for details.
- If you want to cancel the emergency call, push and hold the key again before transmitting the call.
- The emergency call is transmitted one time only or repeatedly until receiving a control code, depending on the pre-setting.

### **SURVEILLANCE KEY “SURV”**

Push to turn the surveillance function ON or OFF.

When this function is turned ON, the beep is not emitted and the LCD backlight does not light when a signal is received or a key is pushed, etc.

### **TX CODE ENTER KEYS “TXCE”**

Push to enter the ID code edit mode directly, for both 5-tone and MSK. Then set the desired digit using [CH Up]/[CH Down]. (p. 15)

**TX CODE CHANNEL SELECT KEY "TXC"**

Push to enter the TX code channel selection mode. Then set the desired channel using [CH Up]/[CH Down]. (pgs. 14, 15)

**TX CODE CHANNEL UP/DOWN KEYS "TXCU" "TXCD"**

Push to select a TX code channel directly.

**ID-MEMORY SELECT KEY "IDMS"**

- Recalls detected ID codes.
  - Push this key, then select the ID code using [CH Up]/[CH Down].
  - Up to 5 ID's are memorized.
- Push and hold for 1 sec. to erase the selected ID's.

**SCRAMBLER/ENCRYPTION KEY "SCR"**

- While in the analog mode operation, push to toggle the voice scrambler function ON and OFF.
- While in the digital mode operation, push to toggle the encryption transmission function ON and OFF.

**COMPANDER KEY "COMP"**

Push to toggle the compander function ON and OFF.

The compander function reduces noise components from the transmitting audio to provide clear communication.

**USER SET MODE KEY "SET"**

- Push and hold for 1 sec. to enter user set mode.
  - During user set mode, push this key to select an item, and change the value or condition using push [CH Up]/[CH Down].
- Push and hold this key for 1 sec. again to exit user set mode.

User set mode is also available via the 'Power ON function.' Refer to (p. 16) also.

**OPT OUT KEYS "OP1" "OP2" "OP3"**

Push to control the output signal level from the optional unit connector.

**OPT MOMENTARY KEYS "O1M" "O2M" "O3M"**

Push to control the output signal level from the optional unit connector.

## ■ Turning power ON

▨ Prior to using the transceiver for the first time, the battery pack must be fully charged for optimum life and operation. (p. 18)

- ① Rotate [VOL] to turn the power ON.
- ② If the transceiver is programmed for a start up password, input the digit codes as directed by your dealer.
  - 10-keypad can be used for password input depending on version.
  - The keys in the table below can be used for password input.
  - The transceiver detects numbers in the same block as identical. Therefore “01234” and “56789” are the same.

KEY	P <sub>0</sub>	P <sub>1</sub>	P <sub>2</sub>	P <sub>3</sub>	(Side1)
NUMBER	0	1	2	3	4
	5	6	7	8	9

- ③ When the “PASSWORD” indication does not clear after inputting 6 digits, the input code number may be incorrect. Turn the power off and start over in this case.

## ◇ Battery type selection

The battery type must be selected according to the attaching battery type when tuning the transceiver ON.

- ➔ While pushing and holding [Emer] and [PTT], rotate [VOL] to toggle the attaching battery type.
  - After the display appears, release [Emer] and [PTT].
  - “DRY BATT” is displayed for about 3 sec. then “Lo” (low power indicator) appears when the battery case operation is selected.
  - “LI-ION” is displayed for about 3 sec. when the Lithium-ion battery operation is selected.
- This operation may not be available depending on the pre-setting. Ask your dealer for details.

## ■ Channel selection

Several types of channel selections are available. Methods may differ according to your system set up.

### **NON-ZONE TYPE:**

To select the desired operating channel:

- Push [CH Up] or [CH Down].
- Rotate [ROTARY SELECTOR]\*.
  - Up to pre-programmed 16 channels can be selected.
- Push one of [MR-CH 1] to [MR-CH 4].

### **ZONE TYPE:**

To select the desired zone:

- Push [Zone], then push [CH Up] or [CH Down].
- Push [Zone Up] or [Zone Down].
- Rotate [ROTARY SELECTOR]\*.
  - Up to pre-programmed 16 zones can be selected.

### ◇ **Voting operation**

The transceiver automatically starts scanning when a zone, specified for the voting operation, is selected.

The voting scan detects the S-meter of the repeater and automatically selects the strongest station.

### **AUTOMATIC SCAN TYPE:**

Channel setting is not necessary for this type. When turning power ON, the transceiver automatically starts scanning. Scanning stops when receiving a call.

\* Depending on the pre-setting.

When [Rotary selector] selects "Operating channel," [CH Up]/[CH Down] are not available.

When [Rotary selector] selects "Operating zone," [Zone]/[Zone Up]/[Zone Down] are not available.

### 3 BASIC OPERATION

## ■ Call procedure

When your system employs tone signalling (excluding CTCSS and DTCS), this call procedure may be necessary prior to voice transmission. The tone signalling employed may be a selective calling system which allows you to call specific station(s) only and prevent unwanted stations from contacting you.

- ① Select the desired TX code channel or 2/5-tone code according to your System Operator's instructions.
  - This may not be necessary depending on programming.
  - Refer to pages 14 or 15 for selection.
- ② Push [Call] (assigned to one of the dealer programmable keys)
- ③ After transmitting, the remainder of your communication can be carried out in the normal fashion.

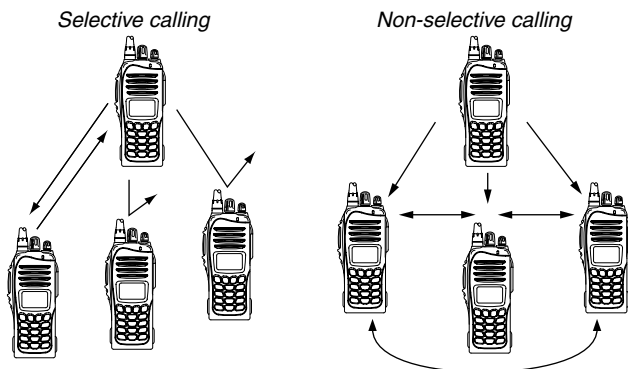

## ■ Receiving and transmitting

**NOTE:** Transmitting without an antenna may damage the transceiver. See (p. 1) for accessory attachments.

### **Receiving:**

- ① Rotate [VOL] to turn the power ON.
- ② Push [CH Up] or [CH Down], or rotate [ROTARY SELECTOR]\* to select the conventional system channel, in sequence.
  - \*Depending on the pre-setting.
- ③ When receiving a call, adjust the audio output level to a comfortable listening level.

### **Transmitting:**

Wait for the channel to become clear to avoid interference.

- ① While pushing and holding [PTT], speak into the microphone at a normal voice level.
  - When a tone signalling system is used, the call procedure described at the previous page may be necessary.
- ② Release [PTT] to return to receive.

**IMPORTANT:** To maximize the audio quality of your signal;

1. Pause briefly after pushing [PTT].
2. Hold the microphone 5 to 10 cm (2 to 4 inches) from your mouth, then speak into the microphone at a normal voice level.

### ◇ Transmitting notes

#### • Transmit inhibit function

The transceiver has several inhibit functions which restrict transmission under the following conditions:

- The channel is in mute condition ('Inaudible' condition; "🔇" (Audible indicator) does not appear.)
- The channel is busy.
- Un-matched (or matched) CTCSS is received. (Depending on the pre-setting.)
- The selected channel is a 'receive only' channel.

#### • Time-out timer

After continuous transmission for the pre-programmed time period, the time-out timer starts, causing the transceiver to stop transmitting.

#### • Penalty timer

Once the time-out timer starts, transmission is further inhibited for a period determined by the penalty timer.

### ◇ TX code channel selection

If the transceiver has [TX Code CH Select] assigned to it, the indication can be toggled between the operating channel number (or name) and TX code channel number (or name). When the TX code channel number (or name) is displayed, [CH Up] or [CH Down] selects the TX code channel.

#### **USING [TX CODE CH SELECT] KEY:**

- ① Push [TX Code CH Select]— a TX code channel number (or name) appears.
- ② Push [CH Up] or [CH Down] to select the desired TX code channel.
- ③ After selecting, push [TX Code CH Select] to set.
  - Return to the stand-by mode.
- ④ Push [Call] to transmit the selected TX code.

#### **USING [TX CODE CH UP]/[TX CODE CH DOWN] KEY:**

If the transceiver has a [TX Code CH Up] or [TX Code CH Down] key assignment, the programmed TX code channel can be selected directly when pushed.

☞ Continue to the next page

---

## 3 BASIC OPERATION

### ◇ TX code number edit (PMR operation only)

If the transceiver has [TX Code CH Select] or [TX Code Enter] assigned to it, TX code contents can be edited within the allowable digits.

#### **USING [TX CODE CH SELECT] KEY:**

- ① Push [TX Code CH Select] to enter the TX code channel selection mode.
  - Select the desired operating channel before entering the TX code channel selection mode if necessary.
- ② Push [TX Code CH Select] for 1 sec. to enter the TX code edit mode.
  - The digit to be edited blinks.
- ③ Push [TX Code CH Select] to select the desired digit to be edited.
- ④ Push [CH Up]/[CH Down] to select the desired digit.
- ⑤ Push [TX Code CH Select] to set. The digit to the right will blink automatically.
- ⑥ Repeat ④ and ⑤ to edit all allowable digits.
- ⑦ After editing, push [TX Code CH Select] to set.
  - Return to the stand-by mode.
- ⑧ Push [Call] to transmit.

#### **USING [TX CODE ENTER] KEY:**

- ① After pushing [TX Code CH Select], push [CH Up] or [CH Down], or push [TX Code CH Up] or [TX Code CH Down] to select the desired TX code channel.
- ② Push [TX Code Enter] to enter the TX code edit mode.
  - The digit to be edited blinks.
- ③ Push [TX Code Enter] to select the desired digit to be edited.
- ④ Push [CH Up]/[CH Down] to select the desired digit.
- ⑤ Push [TX Code Enter] to set. The digit to the right will blink automatically.
- ⑥ Repeat ④ and ⑤ to edit all allowable digits.
- ⑦ After editing, push [TX Code Enter] to set.
  - Return to the stand-by mode.
- ⑧ Push [Call] to transmit.

### ◇ DTMF transmission

If the transceiver has [DTMF Autodial] assigned to it, the automatic DTMF transmission function is available. Up to 8 DTMF channels are available.

- ① Push [DTMF Autodial]— a DTMF channel appears.
- ② Push [CH Up] or [CH Down] to select the desired DTMF channel.
- ③ Push [DTMF Autodial] to transmit the DTMF code.

## ■ User set mode

User set mode is accessed at power ON and allows you to set seldom-changed settings. You can “customize” the transceiver operation to suit your preferences and operating style.

### *Entering the user set mode:*

- ① While pushing and holding [P1] and [P2], rotate [VOL] to turn the power ON.
  - Turn power OFF in advance.
  - “SET MODE” appears for 1 sec at power ON.
- ② Push and hold [P0] to enter user set mode.
- ③ Push [P0] several times to select the appropriate item. Then push [Side2] or [Side3] to set the desired level/condition.
  - Available set mode functions are **Backlight**, **LCD contrast**, **Beep**, **Beep Level**, **Ringer Level**, **SQL Level**, **AF Min Level**, **Mic Gain**, **VOX Gain**, **VOX Delay**, **Battery Voltage**, **Signal Moni** and **Lone Worker**.
- ④ Push and hold [P0] again to exit set mode.

User set mode is also available using a programmable key. Please refer to p. 10 [User Set Mode] section for instructions regarding using the key assigned for user set mode.

**NOTE:** [Side2] or [Side3] and [P0] activate while in the user set mode regardless of the assigned key functions.

## ■ Emergency transmission

When [Emergency] is pushed for the specified time period, an emergency signal is automatically transmitted. (p. 9)

When [Emergency] is pushed for the specified time period, the DTMF emergency signal is transmitted once or repeatedly on the emergency channel. However, when no emergency channel is specified, the signal is transmitted on the previously selected channel.

If you want to cancel the emergency call, push and hold the key again before transmitting the call.

## ■ Man Down Emergency Call

This function requires the optional UT-124R MAN DOWN UNIT and can be performed in conventional mode.

The man down emergency call function transmits an emergency call automatically when the transceiver has been left in a horizontal position.

After the emergency call, the transceiver performs transmission and reception alternately with receiving a signal and emitting audio.

When the emergency reset signal is received, the function is cancelled.



**IMPORTANT:** Set an emergency channel individually, to provide certain emergency call operation is recommended.

---

## 3 BASIC OPERATION

### ■ Scrambler function

The voice scrambler function provides private communication between stations. All versions have a built-in frequency inversion type scrambler; however, an optional rolling or non-rolling type is available as well.

- ① Push [Scrambler] to turn the scrambler function ON.
  - “” (Scrambler indicator) appears.
- ② Push [Scrambler] again to turn the scrambler function OFF.
  - “” (Scrambler indicator) disappears.

### ■ Stun function

When the specified ID, set as a kill ID, is received, the stun function is activated.

When the kill ID is received, the transceiver switches to the password required condition. Entering of the password via the keypad is necessary to operate the transceiver again in this case.

### ■ Priority A channel selection

When one of the following operations is performed, the transceiver selects the Priority A channel automatically.

- Turning the power ON  
The Priority A channel is selected each time the transceiver power is turned ON.
- Status call  
The Priority A channel is selected when transmitting a status call. (BIIS operation only)

## ■ Caution

Misuse of Lithium-Ion batteries may result in the following hazards: smoke, fire, or the battery may rupture. Misuse can also cause damage to the battery or degradation of battery performance.

- ⚠ **DANGER!** Use and charge only specified Icom battery packs with Icom radios or Icom charger. Only Icom battery packs are tested and approved for use and charge with Icom radios or Icom charger. Using third-party or counterfeit battery packs or charger may cause smoke, fire, or cause the battery to burst.

### ◇ Battery caution

- ⚠ **DANGER! DO NOT** hammer or otherwise impact the battery. Do not use the battery if it has been severely impacted or dropped, or if the battery has been subjected to heavy pressure. Battery damage may not be visible on the outside of the case. Even if the surface of the battery does not show cracks or any other damage, the cells inside the battery may rupture or catch fire.

- ⚠ **DANGER! NEVER** use or leave battery packs in areas with temperatures above +60°C (+140°F). High temperature buildup in the battery, such as could occur near fires or stoves, inside a sun heated car, or in direct sunlight may cause the battery to rupture or catch fire. Excessive temperatures may also degrade battery performance or shorten battery life.
- ⚠ **DANGER! DO NOT** expose the battery to rain, snow, seawater, or any other liquids. Never charge or use a wet battery. If the battery gets wet, be sure to wipe it dry before using. The battery is not waterproof.
- ⚠ **DANGER! NEVER** incinerate used battery packs since internal battery gas may cause them to rupture, or may cause an explosion.
- ⚠ **DANGER! NEVER** solder the battery terminals or NEVER modify the battery pack. This may cause heat generation, and the battery may rupture, emit smoke or catch fire.
- ⚠ **DANGER!** Use the battery only with the transceiver for which it is specified. Never use a battery with any other equipment, or for any purpose that is not specified in this instruction manual.
- ⚠ **DANGER!** If fluid from inside the battery gets in your eyes, blindness can result. Rinse your eyes with clean water, without rubbing them, and see a doctor immediately.

---

## 4 BATTERY CHARGING

- **WARNING!** Immediately stop using the battery if it emits an abnormal odor, heats up, or is discolored or deformed. If any of these conditions occur, contact your Icom dealer or distributor.
- **WARNING!** Immediately wash, using clean water, any part of the body that comes into contact with fluid from inside the battery.
- **WARNING! NEVER** put the battery in a microwave oven, high-pressure container, or in an induction heating cooker. This could cause a fire, overheating, or cause the battery to rupture.
- **CAUTION!** Always use the battery within the specified temperature range for the transceiver (−30°C to +60°C; −22°F to +140°F) and the battery itself (−20°C to +60°C; −4°F to +140°F). Using the battery out of its specified temperature range will reduce the battery's performance and battery life.
- **CAUTION!** Shorter battery life could occur if the battery is left fully charged, completely discharged, or in an excessive temperature environment (above +50°C; +122°F) for an extended period of time. If the battery must be left unused for a long time, it must be detached from the radio after discharging. You may use the battery until the remaining capacity is about half, then keep it safely in a cool dry place with the temperature between −20°C to +20°C (−4°F to +68°F).

### ◇ Charging caution

- ⚠ **DANGER! NEVER** charge the battery pack in areas with extremely high temperatures, such as near fires or stoves, inside a sun heated car, or in direct sunlight. In such environments, the safety/protection circuit in the battery will activate, causing the battery to stop charging.
- **WARNING! NEVER** charge or leave the battery in the battery charger beyond the specified time for charging. If the battery is not completely charged by the specified time, stop charging and remove the battery from the battery charger. Continuing to charge the battery beyond the specified time limit may cause a fire, overheating, or the battery may rupture.
- **WARNING! NEVER** insert the transceiver (battery attached to the transceiver) into the charger if it is wet or soiled. This could corrode the battery charger terminals or damage the charger. The charger is not waterproof.
- **CAUTION! NEVER** charge the battery outside of the specified temperature range: BC-160 (0°C to +40°C; +32°F to +104°F). Icom recommends charging the battery at +20°C (+68°F). The battery may heat up or rupture if charged out of the specified temperature range. Additionally, battery performance or battery life may be reduced.

## ■ Optional battery chargers

### ◇ Rapid charging with the BC-160

The optional BC-160 provides rapid charging of the Li-Ion battery pack. Charging period: Approx. 3 hours (with BP-232N)

The following items are additionally required:

- An AC adapter (may be supplied with BC-160 depending on version) or the DC power cable (OPC-515L/CP-17L).

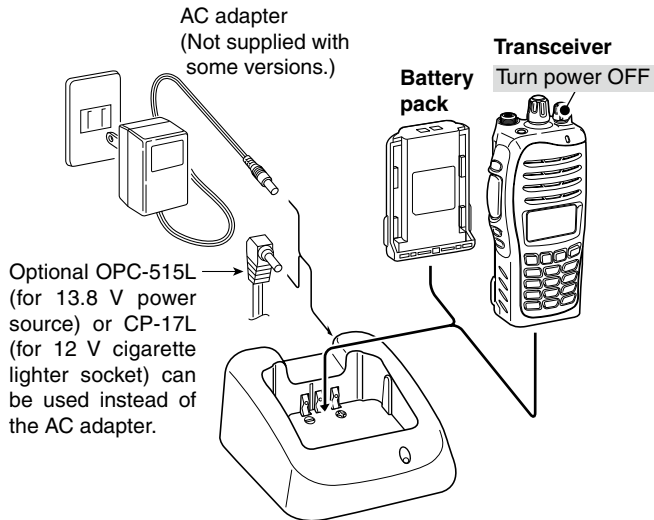

### ◇ Regular charging with the BC-171

The optional BC-171 provides regular charging of the Li-Ion battery pack. Charging period: Approx. 10 hours (with BP-232N)

The following items are additionally required:

- An AC adapter (may be supplied with BC-171 depending on version) or the DC power cable (OPC-515L/CP-17L).

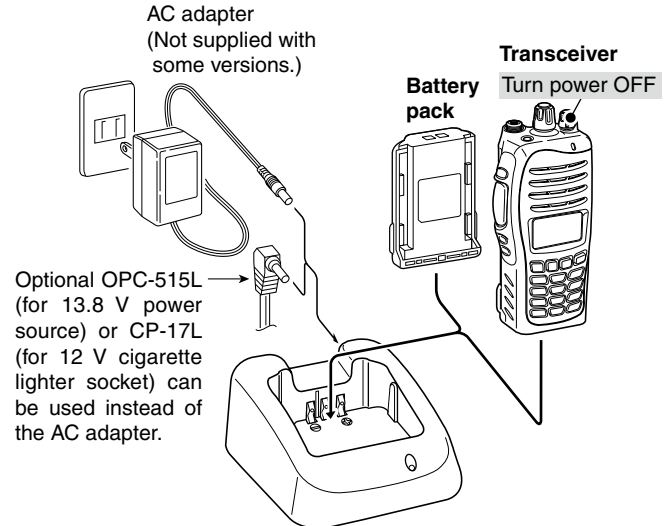

## 4 BATTERY CHARGING

### ◇ AD-106 installation

The AD-106 CHARGER ADAPTER must be installed into the BC-119N or BC-121N before battery charging.

- ➔ Connect the AD-106 CHARGER ADAPTER and the BC-119N/BC-121N as below, then install the AD-106 into the holder space of the BC-119N or BC-121N with the supplied screws.

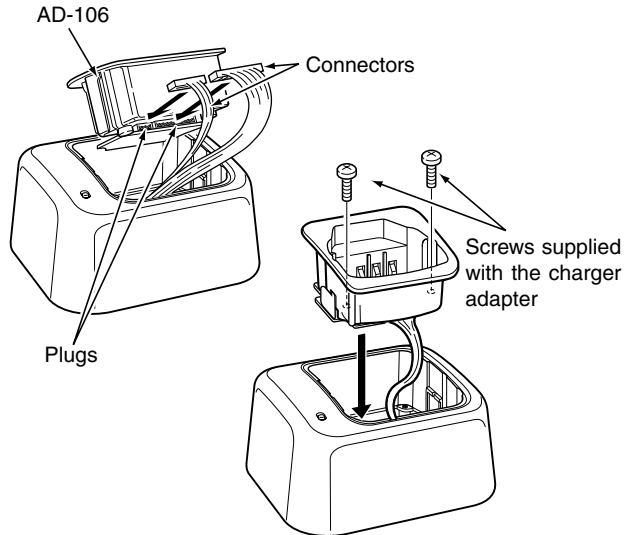

### ◇ Rapid charging with the BC-119N+AD-106

The optional BC-119N provides rapid charging of the Li-Ion battery pack. Charging period: Approx. 3 hours (with BP-232N)

The following items are additionally required.

- AD-106 CHARGER ADAPTER (purchase separately)
- An AC adapter (may be supplied with BC-119N depending on version) or the DC power cable (OPC-515L/CP-17L).

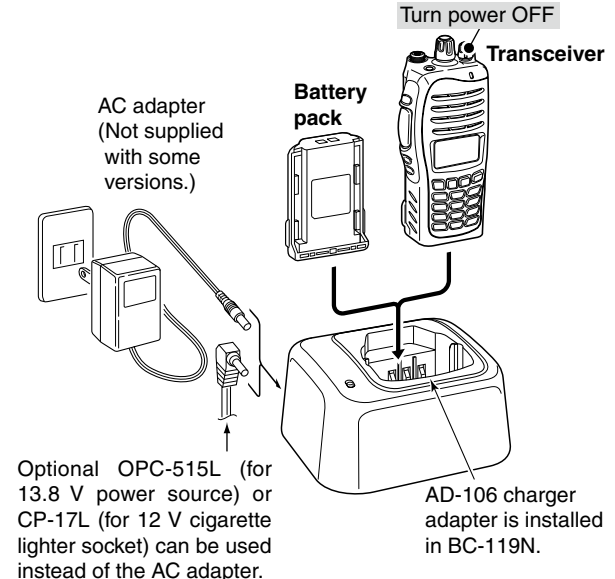

◇ **Rapid charging with the BC-121N+AD-106**

The optional BC-121N allows up to 6 battery packs to be charged simultaneously. Charging period: Approx. 3 hours (with BP-232N)

The following items are additionally required.

- Six AD-106 CHARGER ADAPTERS (purchase separately)
- An AC adapter (BC-157) or the DC power cable (OPC-656)

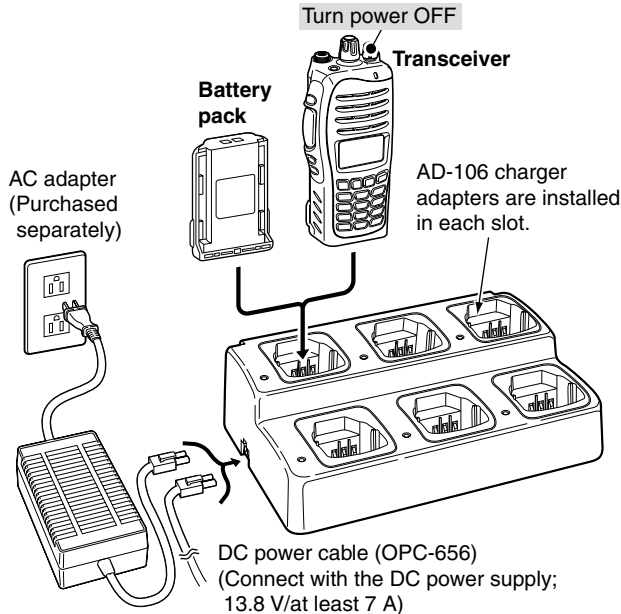

**IMPORTANT: Battery charging caution**

Ensure the guide lobes on the battery pack are correctly aligned with the guide rails inside the charger adapter. (This illustration is described with the BC-160.)

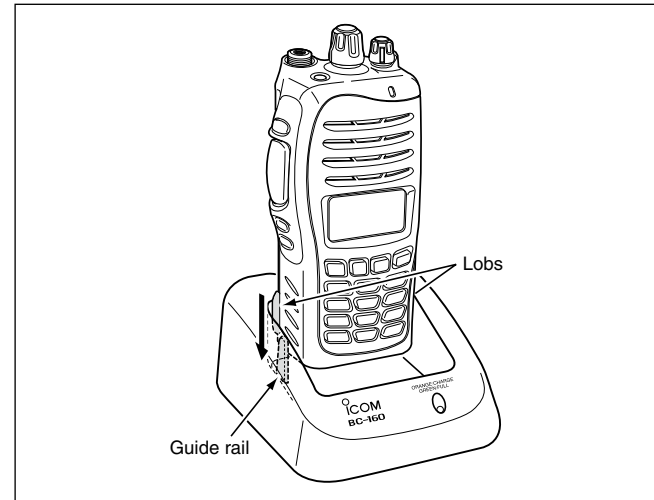

## ■ Optional battery case (BP-240)

When using the optional battery case attached to the transceiver, install 6 × AAA (LR03) size alkaline batteries as illustrated at right.

- ① Unhook the battery cover release hook (❶), and open the cover in the direction of the arrow (❷). (Fig.1)
- ② Then, install 6 × AAA (LR03) size alkaline batteries. (Fig.2)
  - Install the alkaline batteries only.
  - Be sure to observe the correct polarity.
  - Do not pin the ribbon under the batteries.
- ③ Fit the cover in the direction of the arrow (❸), then close (❹). And hook the battery cover release hook until it makes a 'click' sound (❺). (Fig.3)

### CAUTION!

- When installing batteries, make sure they are all the same brand, type and capacity. Also, do not mix new and old batteries together.
- Keep battery contacts clean. It's a good idea to clean battery terminals once a week.
- Never incinerate used battery cells since internal battery gas may cause them to rupture.
- Never expose a detached battery case to water. If the battery case gets wet, be sure to wipe it dry before using it.

**NOTE:** When the optional battery case is attached, the battery type must be selected to "DRY BATT" when turning the transceiver ON. (p. 11)

Fig.1

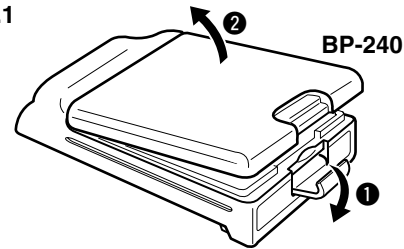

Fig.2

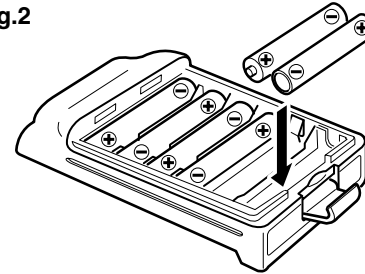
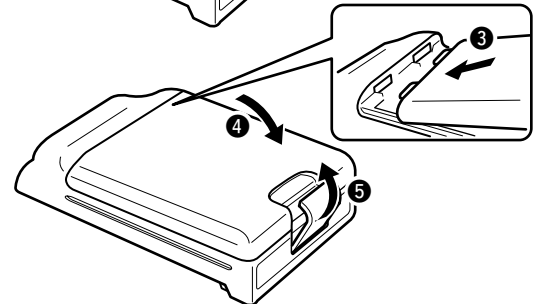
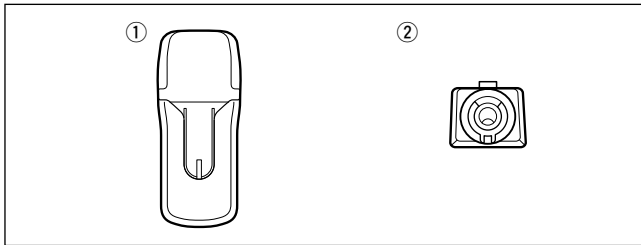

Fig.3



## ■ MB-93 contents

	Qty.
① Belt clip .....	1
② Base clip .....	1



## ■ To attach

- ① Release the battery pack if it is attached. (p. 2)
- ② Slide the base clip in the direction of the arrow until the base clip is locked and makes a 'click' sound.

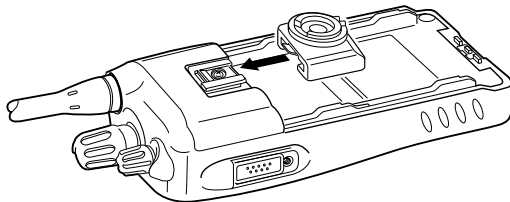

- ③ Clip the belt clip to a part of your belt. And insert the transceiver into the belt clip until the base clip inserted fully into the groove.

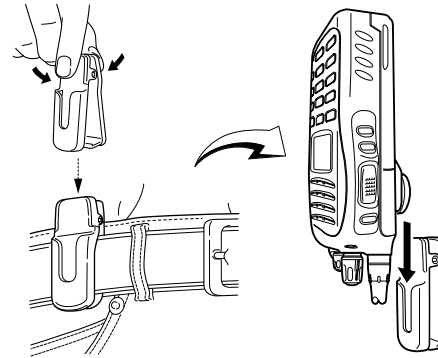

- ④ Once the transceiver is locked in place, it swivels as illustrated below.

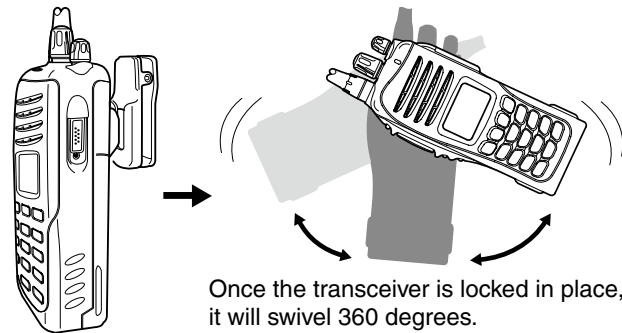

## 6 SWIVEL BELT CLIP

### ■ To detach

- ① Turn the transceiver upside down in the direction of the arrow and pull out from the belt clip.

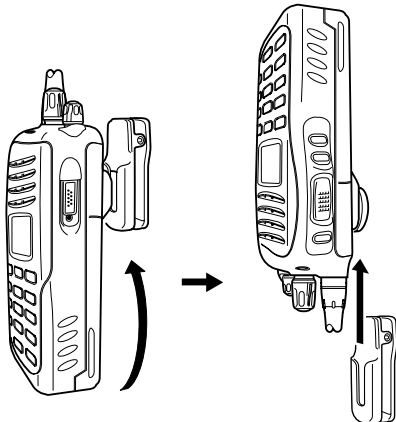

- ② Release the battery pack if it is attached. (p. 2)
- ③ Pinch the clip (1), and slide the base clip in the direction of the arrow (2).

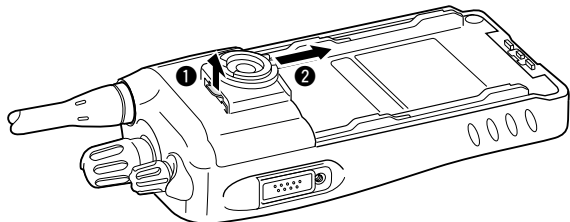

**CAUTION!**  
**HOLD THE TRANSCEIVER TIGHTLY, WHEN HANGING OR DETACHING THE TRANSCEIVER FROM THE BELT CLIP.**

Otherwise the transceiver may not be attached to the holder or swivel properly if the transceiver is accidentally dropped and the base clip is scratched or damaged.

## ■ Optional HM-169/170GP description

### TOP KEY

(for HM-170GP only)  
Desired functions can be programmed by your dealer.

### PTT SWITCH

Push and hold to transmit;  
release to receive.

Turn the transceiver power OFF while connecting the HM-169/170GP.

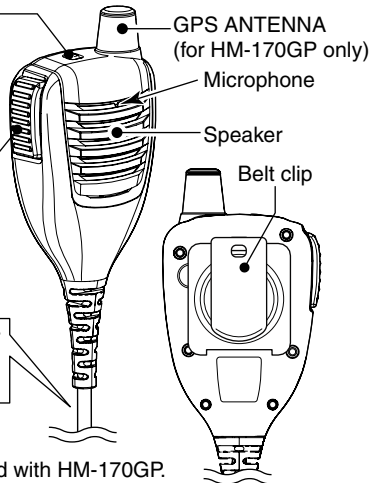

This illustration is described with HM-170GP.

**NEVER** immerse the connector in water. If the connector becomes wet, be sure to dry it **BEFORE** attaching it to the transceiver.

**NOTE:** The microphone is located at the top of the speaker-microphone, as shown in the diagram above. To maximize the readability of your transmitted signal (voice), hold the microphone approx. 5 to 10 cm (2 to 4 inches) from your mouth, and speak in a normal voice level.

## ■ To attach

Attach the connector of the speaker-microphone into the multi connector on the transceiver and tighten the screw.

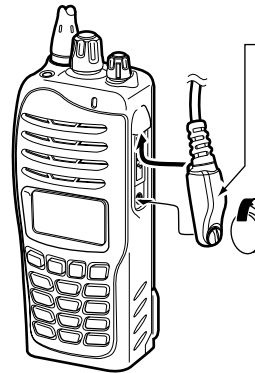

**CAUTION:** Attach the multi connector snugly, but do not overtighten.

A loose connection will allow water intrusion into the connector; an overtightened connector will damage the connector pins in the transceiver.

**IMPORTANT:** **KEEP** the connector cover attached to the transceiver when the speaker-microphone is not in use. (p. 3)

Water will not get into the transceiver even if the cover is not attached, however, the terminals (pins) will become rusty, or the transceiver will function abnormally if the connector becomes wet.

### ◇ BATTERY PACKS

Battery pack	Voltage	Capacity	Battery life* <sup>1</sup>
<b>BP-230N</b>	7.4 V	980 mAh	7.35 hrs.
<b>BP-232N</b>	7.4 V	2000 mAh	14 hrs.
<b>BP-240</b>	Battery case for AAA (LR03) × 6 alkaline		—* <sup>2</sup>

\*<sup>1</sup> When the power save function is turned ON, and the operating periods are calculated under the following conditions;  
TX : RX : standby = 5 : 5 : 90

\*<sup>2</sup> Operating period depends on the alkaline cells used.

### ◇ CHARGERS

- **BC-119N** DESKTOP CHARGER + **AD-106** CHARGER ADAPTER + **BC-145** AC ADAPTER

For rapid charging of battery pack. An AC adapter is supplied with the charger depending on versions.

Charging time: approx. 3 hours when BP-232N is attached.

- **BC-121N** MULTI-CHARGER + **AD-106** CHARGER ADAPTER (6 pcs.) + **BC-157** AC ADAPTER

For rapid charging of up to 6 battery packs (six AD-106s are required) simultaneously. An AC adapter should be purchased separately.

Charging time: approx. 3 hours when BP-232N is attached.

- **BC-160** DESKTOP CHARGER + **BC-145** AC ADAPTER

For rapid charging of battery pack. An AC adapter is supplied with the charger depending on versions.

Charging time: approx. 3 hours when BP-232N is attached.

- **BC-171** DESKTOP CHARGER + **BC-147** AC ADAPTER

For regular charging of battery packs. We recommend that the BP-230N charging. An AC adapter is supplied with the charger depending on versions.

Charging time: approx. 10 hours when BP-232N is attached.  
approx. 4 hours when BP-230N is attached.

### ◇ BELT CLIPS

- **MB-93** SWIVEL BELT CLIP
- **MB-94** BELT CLIP  
Exclusive alligator-type belt clip.
- **MB-96N/96F** LEATHER BELT HANGER

### ◇ OPTIONAL UNITS

- **UT-96R** 2/5 TONE UNIT
- **UT-109R /UT-110R** SCRAMBLER UNITS  
Non-rolling type (UT-109R)/Rolling type (UT-110R) voice scrambler unit provides higher communication security.
- **UT-126H** DIGITAL MODULATOR/DEMODULATOR UNIT  
Provides 6.25 kHz digital mode operation.
- **UT-124R** MAN DOWN UNIT  
Provides a measure of safety when working in a hazardous environment, etc.

◇ **DC CABLES**

- **CP-17L** CIGARETTE LIGHTER CABLE  
Allows charging of the battery pack through a 12 V cigarette lighter socket. (For BC-119N)
- **OPC-515L/OPC-656** DC POWER CABLES  
Allows charging of the battery pack using a 13.8 V power source instead of the AC adapter.  
OPC-515L : For BC-119N  
OPC-656 : For BC-121N

◇ **OTHER OPTIONS**

- **SP-13** EARPHONE  
Provides clear receive audio in noisy environment.
- **AD-52** EARPHONE ADAPTER  
Provides clear receive audio in noisy environment.
- **HM-131SC/HM-159SC** SPEAKER-MICROPHONE  
Combination speaker-microphone that provides convenient operation while hanging the transceiver from your belt.
- **HM-169** SPEAKER-MICROPHONE  
Rugged type speaker-microphone.
- **HM-170GP** SPEAKER-MICROPHONE  
GPS speaker-microphone for BISS and Digital modes operation.
- **HS-94/HS-95/HS-97** HEADSET + **VS-1SC** VOX/PTT CASE  
HS-94: Ear-hook type  
HS-95: Neck-arm type  
HS-97: Throat microphone  
VS-1SC: VOX/PTT switch box for hands-free operation, etc.

◇ **ANTENNAS**

- **FA-SC56VS/FA-SC57VS/FA-SC73US** STUBBY ANTENNAS  
Shorter VHF or UHF antennas.  
FA-SC56VS: Frequency range 150–162 MHz  
FA-SC57VS: Frequency range 160–174 MHz  
FA-SC73US: Frequency range 450–490 MHz
- **FA-SC25V/FA-SC55V/FA-SC25U/FA-SC57U/FA-SC72U** FLEXIBLE ANTENNAS  
VHF or UHF antennas.  
FA-SC25V: Frequency range 136–150 MHz  
FA-SC55V: Frequency range 150–174 MHz  
FA-SC25U: Frequency range 400–430 MHz  
FA-SC57U: Frequency range 430–470 MHz  
FA-SC72U: Frequency range 470–520 MHz
- **FA-SC61VC/FA-SC61UC** CUT ANTENNAS  
FA-SC61VC: 136–174 MHz  
FA-SC61UC: 380–520 MHz

Some options may not be available in some countries. Please ask your dealer for details.

## 8 OPTIONS

### ◇ About VS-1SC VOX/PTT CASE

The VS-1SC is a VOX/PTT unit for Icom handheld transceivers, and allows you hands-free operation.

An optional headset (HS-94, etc.) is required for operation.

- The VOX (Voice Operated Transmission) function starts transmission without pushing PTT switch when you speak into the microphone; then, automatically returns to receive when you stop speaking.

### Features

- ➔ 9-pin Spring-plug type head SP/MIC plug is equipped
- ➔ Water resistant construction
- ➔ Durable construction
- ➔ Equipped with a PTT switch and revolving clip

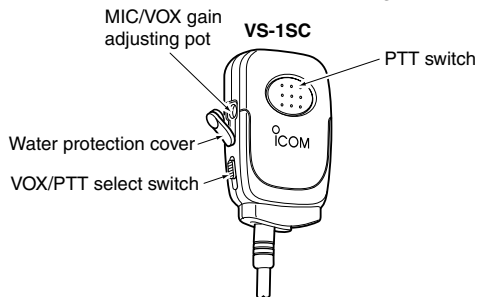

### VOX gain and delay adjustment

- ① Attach the connector of the VS-1SC into the multi-connector on the transceiver and tighten the screw.
  - Toggle the VOX/PTT select switch to [VOX].
- ② Enter user set mode. (p. 16)
- ③ Push [P0] several times to select the “VOX Gain” or “VOX Delay” items. Then, push [Side2] or [Side3] to set the desired level/condition.
- ④ Rotate [VOL] to turn the power OFF to exit user set mode.

### • VOX Gain

The VOX sensitivity level can be adjusted from OFF or 1 to 6 (more sensitive).

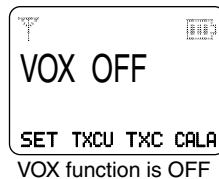

[Side2]  
Push  
[Side3]

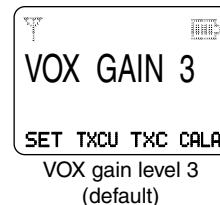

• **VOX Delay**

The VOX delay time can be set from 0.5 to 3.0 sec. (0.5 sec. step) for a convenient interval before returning to receive.

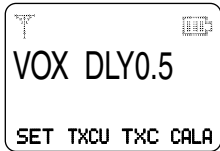

0.5 sec (min.)  
(default)

[Side2]  
Push  
[Side3]

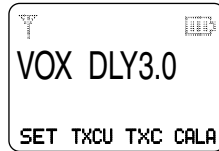

3.0 sec (max.)

/// **NOTE:** MIC/VOX gain can be adjusted via the Adjusting pot using a thin screw driver.



Your Icom radio generates RF electromagnetic energy during transmit mode. This radio is designed for and classified as “Occupational Use Only”, meaning it must be used only during the course of employment by individuals aware of the hazards, and the ways to minimize such hazards.

This radio is NOT intended for use by the “General Population” in an uncontrolled environment.

This radio has been tested and complies with the FCC RF exposure limits for “Occupational Use Only”. In addition, your Icom radio complies with the following Standards and Guidelines with regard to RF energy and electromagnetic energy levels and evaluation of such levels for exposure to humans:

- FCC OET Bulletin 65 Edition 97-01 Supplement C, Evaluating Compliance with FCC Guidelines for Human Exposure to Radio Frequency Electromagnetic Fields.
- American National Standards Institute (C95.1-1992), IEEE Standard for Safety Levels with Respect to Human Exposure to Radio Frequency Electromagnetic Fields, 3 kHz to 300 GHz.
- American National Standards Institute (C95.3-1992), IEEE Recommended Practice for the Measurement of Potentially Hazardous Electromagnetic Fields— RF and Microwave.
- The following accessories are authorized for use with this product. Use of accessories other than those specified may result in RF exposure levels exceeding the FCC requirements for wireless RF exposure.; Belt Clip (MB-93, MB-94, MB-96N and MB-96F), Rechargeable Li-Ion Battery Pack (BP-230N and BP-232N), Alkalies Battery Case (BP-240) and Speaker-microphone (HM-131SC, HM-159SC, HM-169 and HM-170GP).



CAUTION

**To ensure that your exposure to RF electromagnetic energy is within the FCC allowable limits for occupational use, always adhere to the following guidelines:**

- **DO NOT** operate the radio without a proper antenna attached, as this may damage the radio and may also cause you to exceed FCC RF exposure limits. A proper antenna is the antenna supplied with this radio by the manufacturer or antenna specifically authorized by the manufacturer for use with this radio.
- **DO NOT** transmit for more than 50% of total radio use time (“50% duty cycle”). Transmitting more than 50% of the time can cause FCC RF exposure compliance requirements to be exceeded. The radio is transmitting when the TX indicator lights red. You can cause the radio to transmit by pressing the “PTT” switch.
- **ALWAYS keep** the antenna at least 2.5 cm (1 inch) away from the body when transmitting and only use the Icom belt-clips listed on page 27 when attaching the radio to your belt, etc., to ensure FCC RF exposure compliance requirements are not exceeded. To provide the recipients of your transmission the best sound quality, hold the antenna at least 5 cm (2 inches) from your mouth, and slightly off to one side.

The information listed above provides the user with the information needed to make him or her aware of RF exposure, and what to do to assure that this radio operates within the FCC RF exposure limits of this radio.

**Electromagnetic Interference/Compatibility**

During transmissions, your Icom radio generates RF energy that can possibly cause interference with other devices or systems. To avoid such interference, turn off the radio in areas where signs are posted to do so. **DO NOT** operate the transmitter in areas that are sensitive to electromagnetic radiation such as hospitals, aircraft, and blasting sites.

**Occupational/Controlled Use**

The radio transmitter is used in situations in which persons are exposed as consequence of their employment provided those persons are fully aware of the potential for exposure and can exercise control over their exposure.

**Count on us!**

A-6638H-1EX  
Printed in Japan  
© 2007 Icom Inc.

Printed on recycled paper with soy ink.

**Icom Inc.**

1-1-32 Kamiminami, Hirano-ku, Osaka 547-0003, Japan